

# ADS Application Notes

Microwave Laboratory, Department of Electronic Engineering  
The Chinese University of Hong Kong

## Application Notes for ADS

Wong Shing Chi

May 15, 2001

### Introduction

This is a project of Low Noise Amplifier (LNA) design. In this project, I will explain the necessary procedures in designing Low Noise Amplifier step by step. We have to:

1. Download and use the ADS transistor model
2. Perform the DC analysis
3. Simulate the S-parameters

Notice: This report does not include the theory of designing Low Noise Amplifier.

### Transistor Model

The transistor used in this project is HBFP-0450. It can be found in the manufacturer's homepage: <http://www.agilent.com>. The datasheet and the information of this transistor can be searched in the category of RF transistor. The ADS HBFP 0450 model can be downloaded in this homepage also.



After unzipped the downloaded file of the transistor model, we can start to use the download model by ADS.

1. Open the ADS program. Choose "File→ open project" to open the project from the download file.

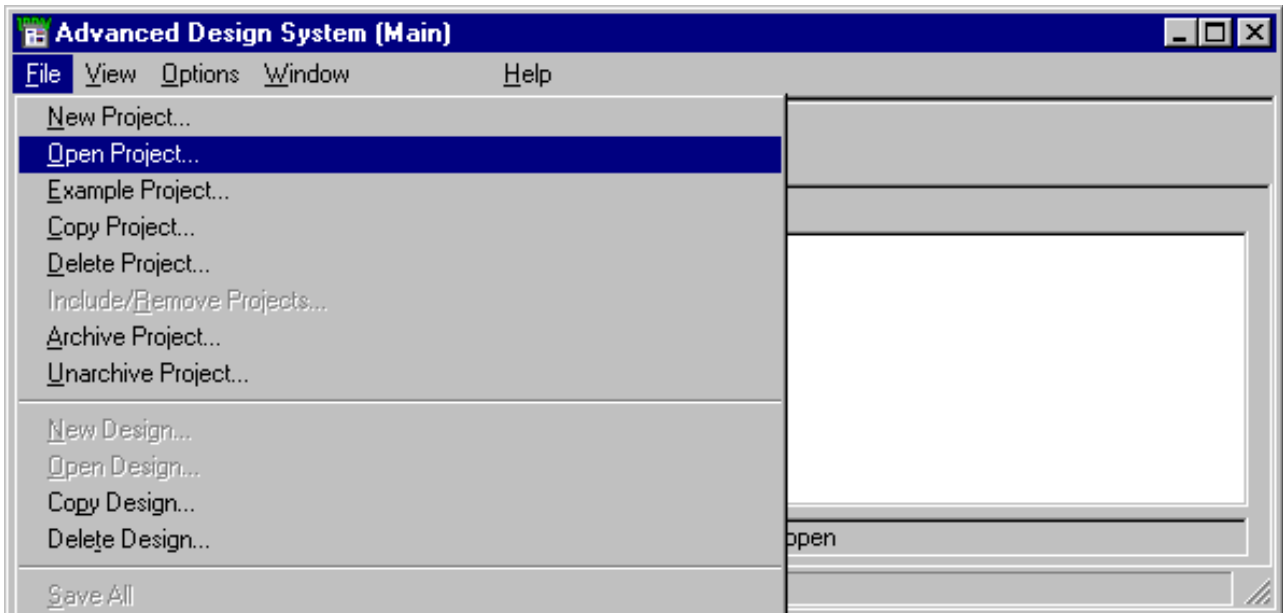

2. Choose the project directory of the download file. The project directory of the download file is hbp0450->hbp\_0450\_ZZ->HBFP\_prj.

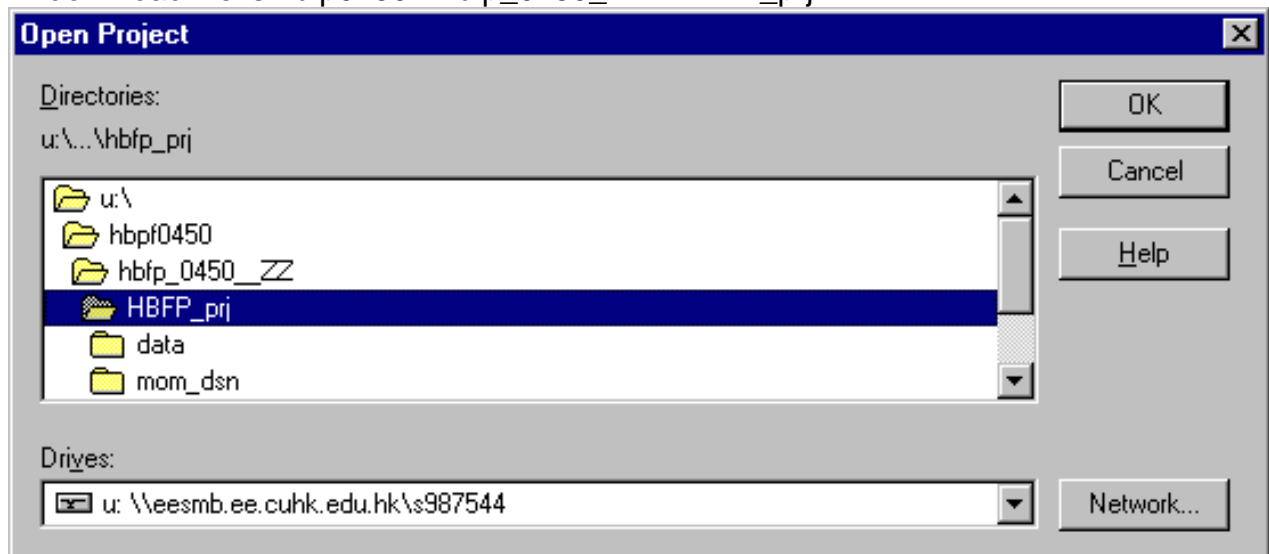

3. Push “OK” button. You can get the ADS design page.

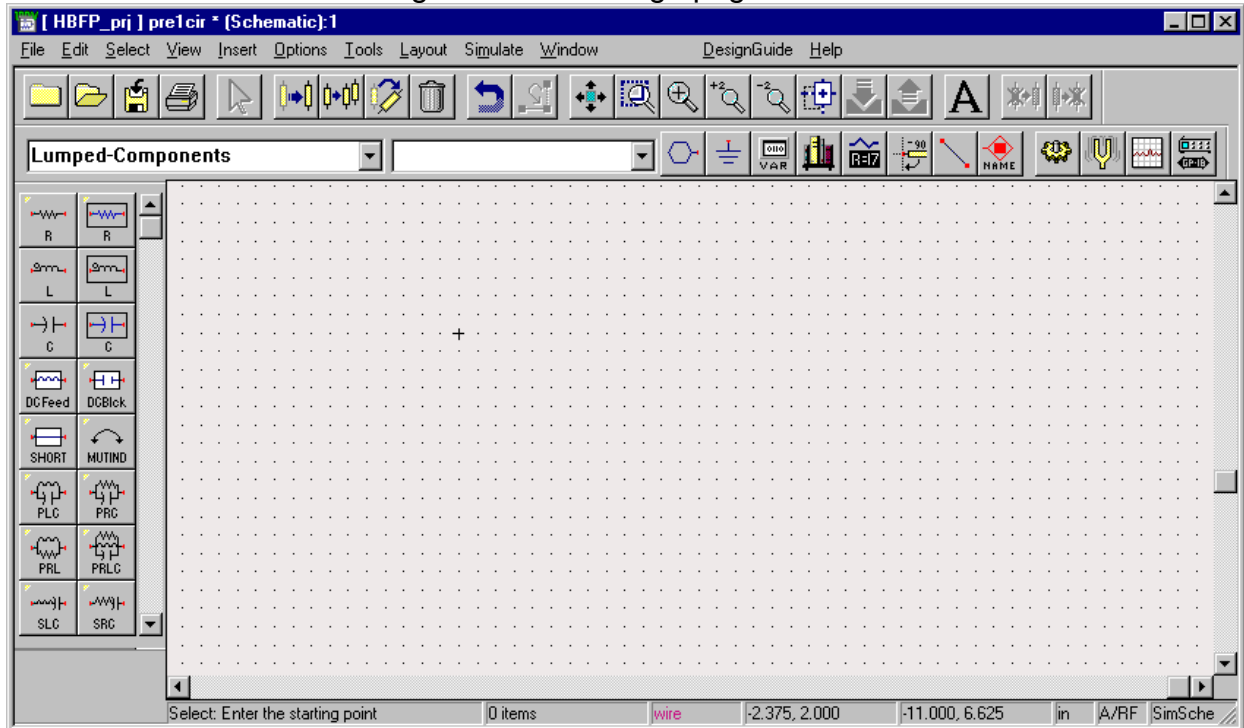

4. Next step, we need to use the library icon to get the symbol into your design circuit.

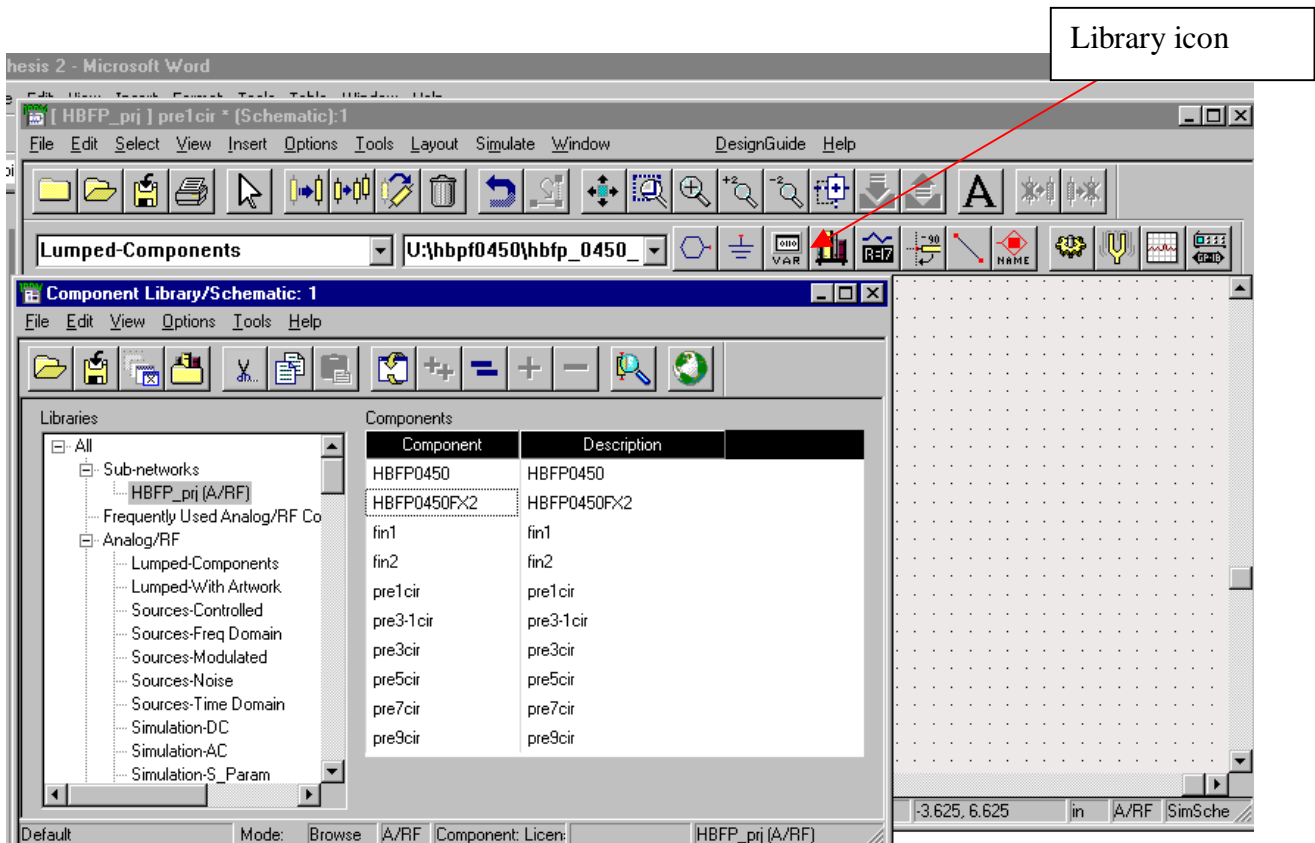

- Choose “HBFP\_prj(A/RF)” in the left hand side window. Drag and drop the “HBFG0450FXZ” from the right hand side window to the design page as following.

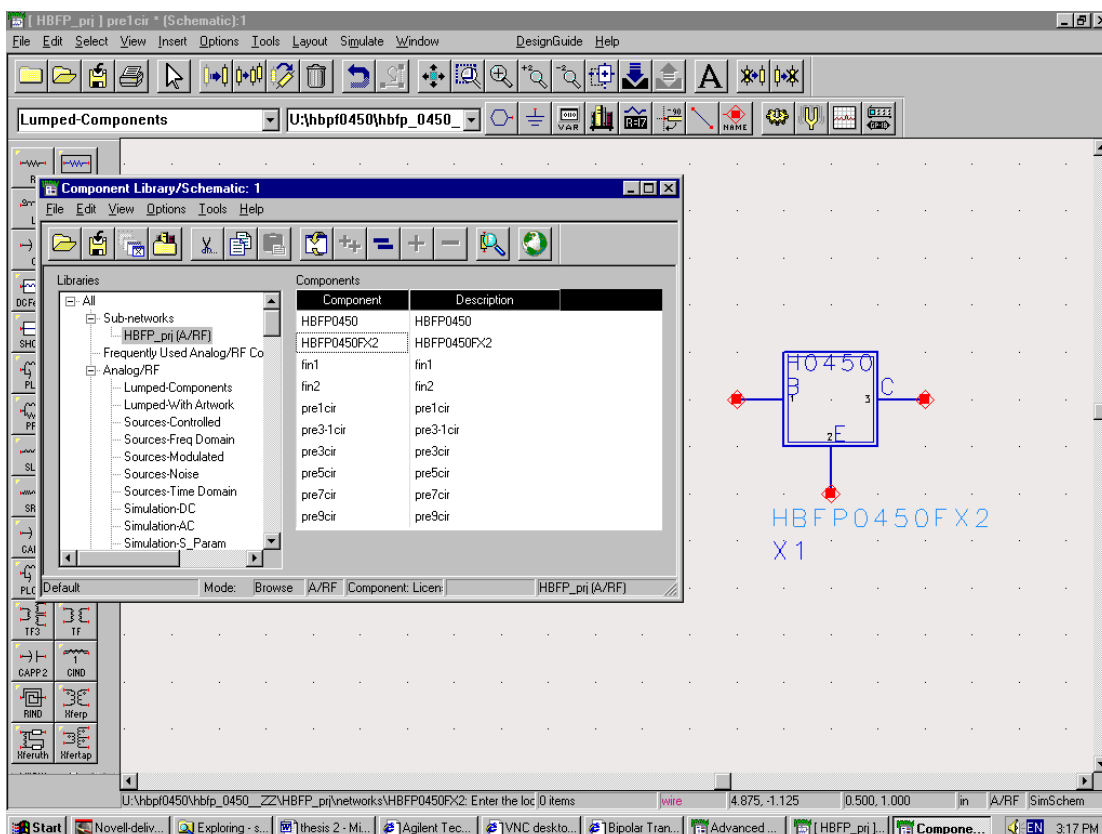

Now, we have finished the steps to use the transistor model file. Next, we will start to draw the schematic as well as the DC and S-parameters simulation.

## Circuit Schematic Construction

We are now going on to add the components into the design. Resistors, capacitors and inductors can be found in the Lumped-element category. DC voltage source is in the Sources-Time Domain category. The ground and the connecting wire are in the icons under the toolbar.

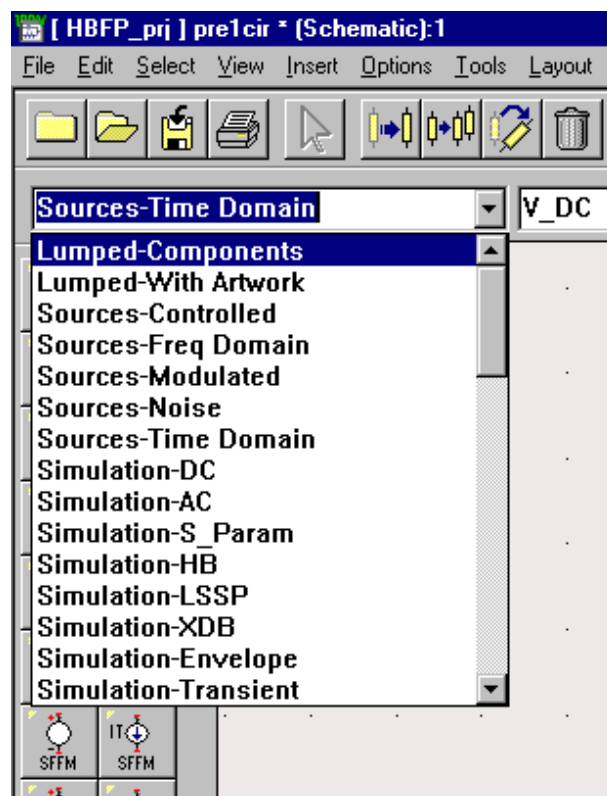

Then we can start to simulate the S-parameters simulation now. All the S-parameters simulation components can be found in the Simulation-S\_Param category. We need Sweep Plan, S-parameters and term for S-parameters simulation.

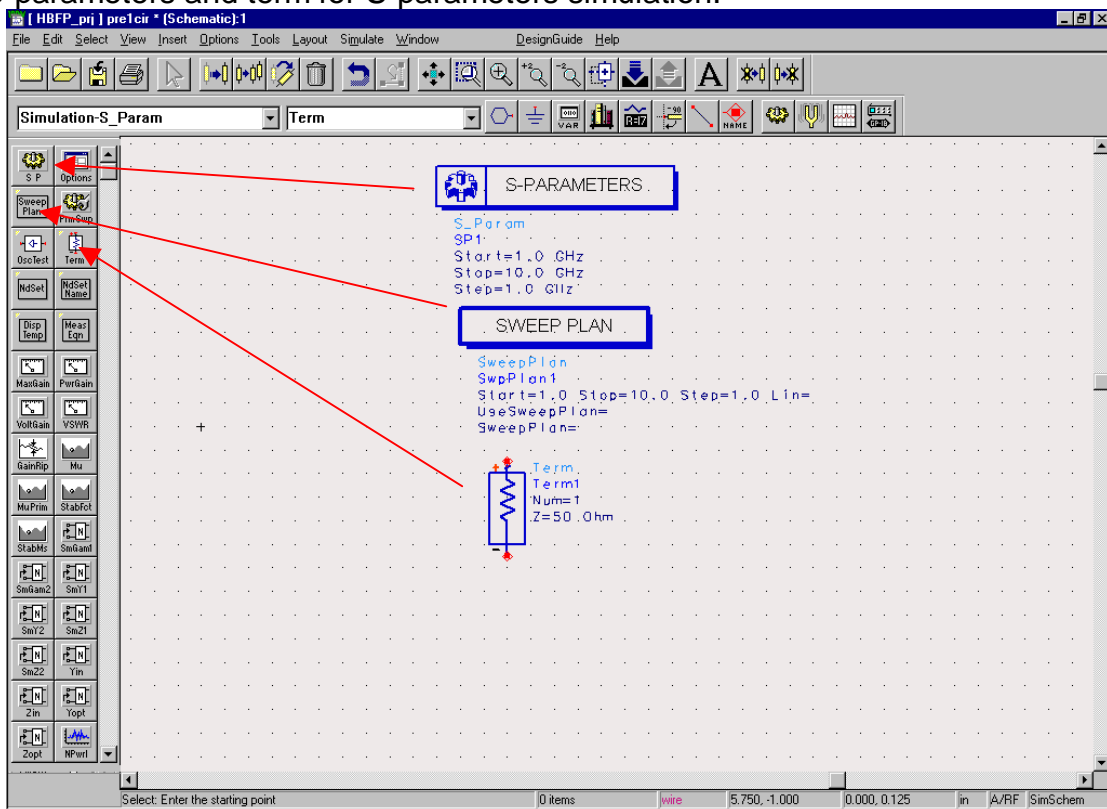

The following is the completed circuit schematic used in the simulation.

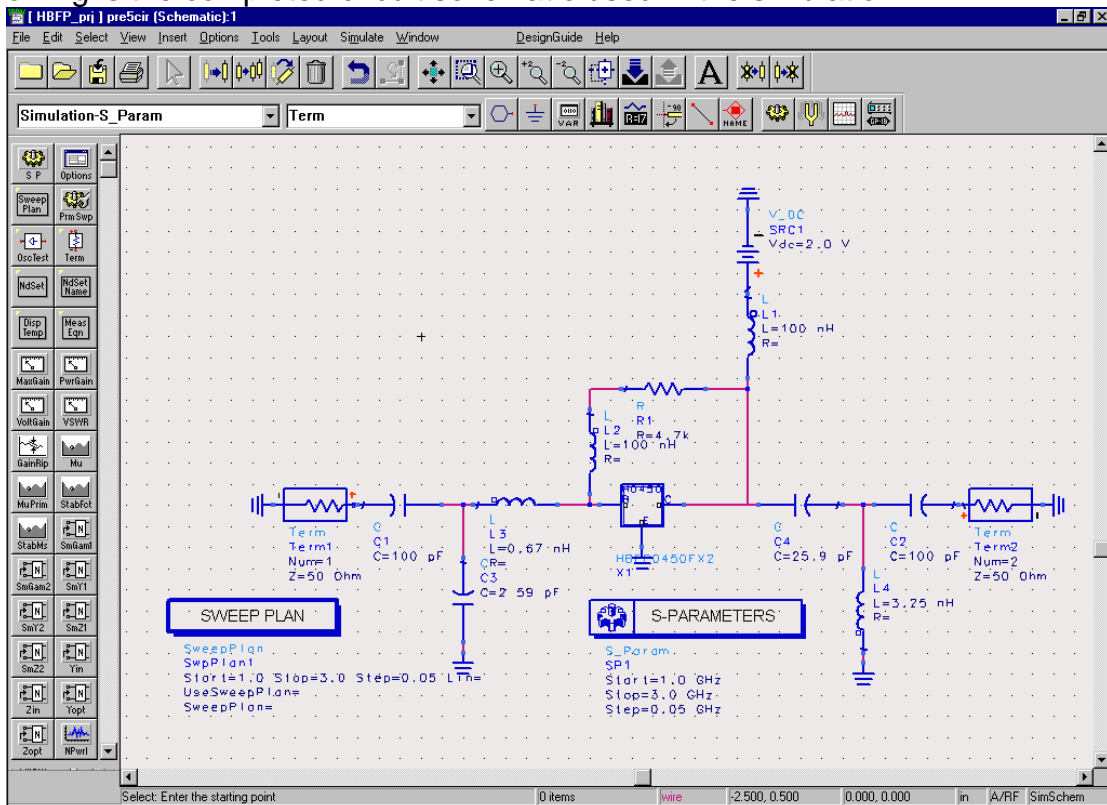

# Circuit Simulation

After the plotting schematic, we now can simulate the circuit. The s-parameter of the circuit will be found here first.

1. Select the “simulate->simulate the circuit”.

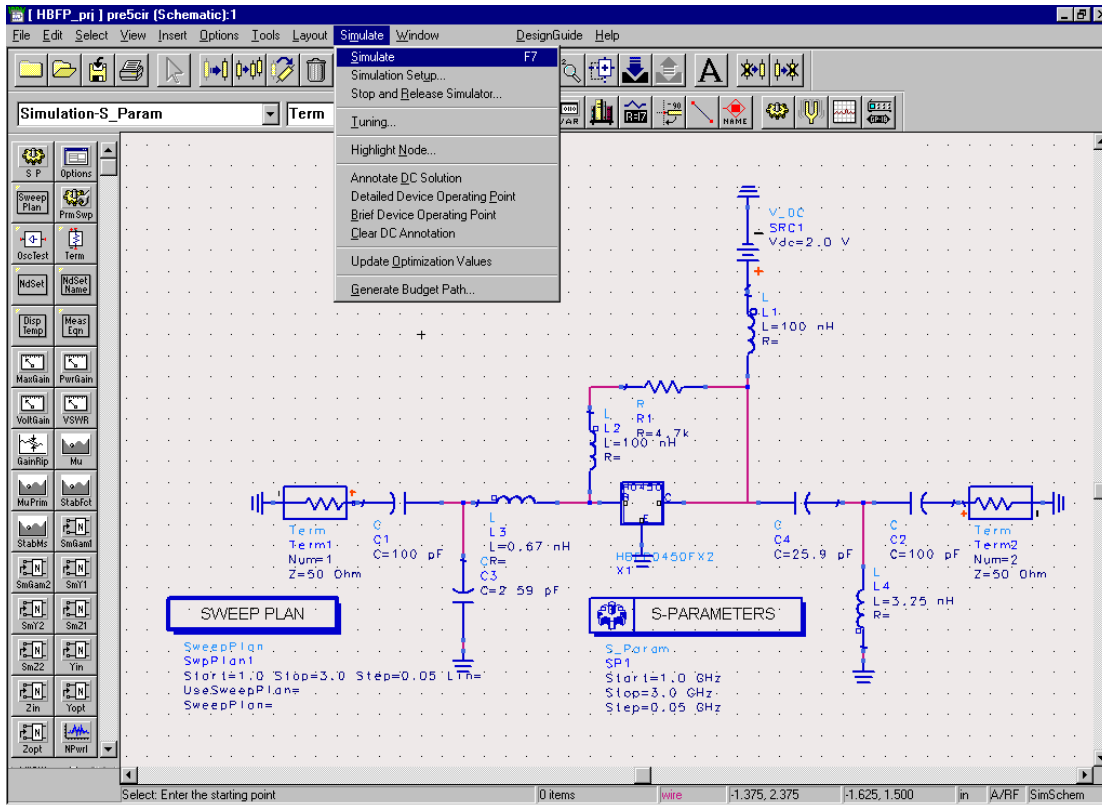

2. After the simulation process finished, a data presentation window is prompted.

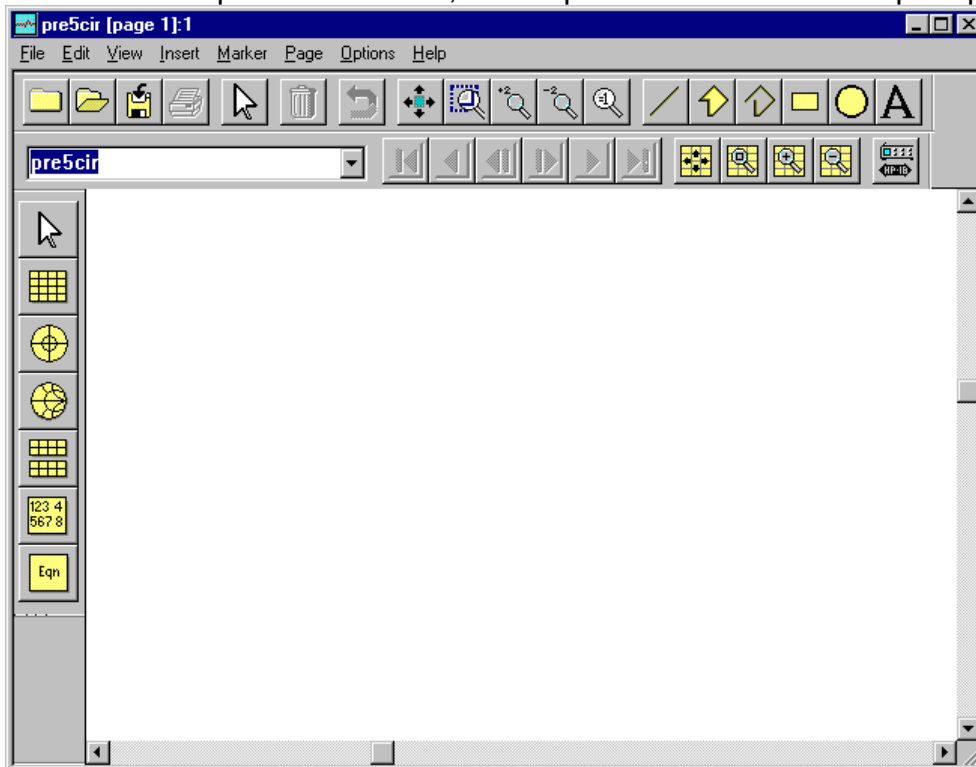

3. Choose the rectangular plot to plot the s-parameter.

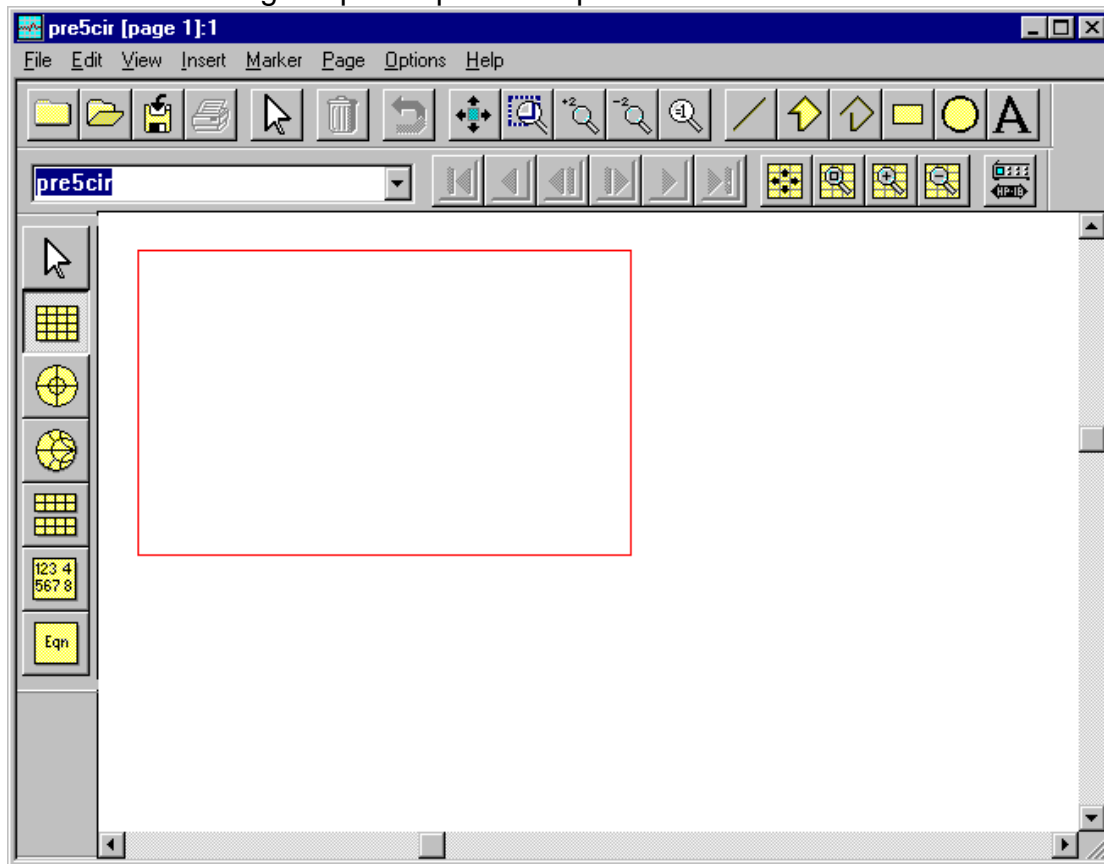

4. Double click the S-parameter for the graph and choose the unit you want.

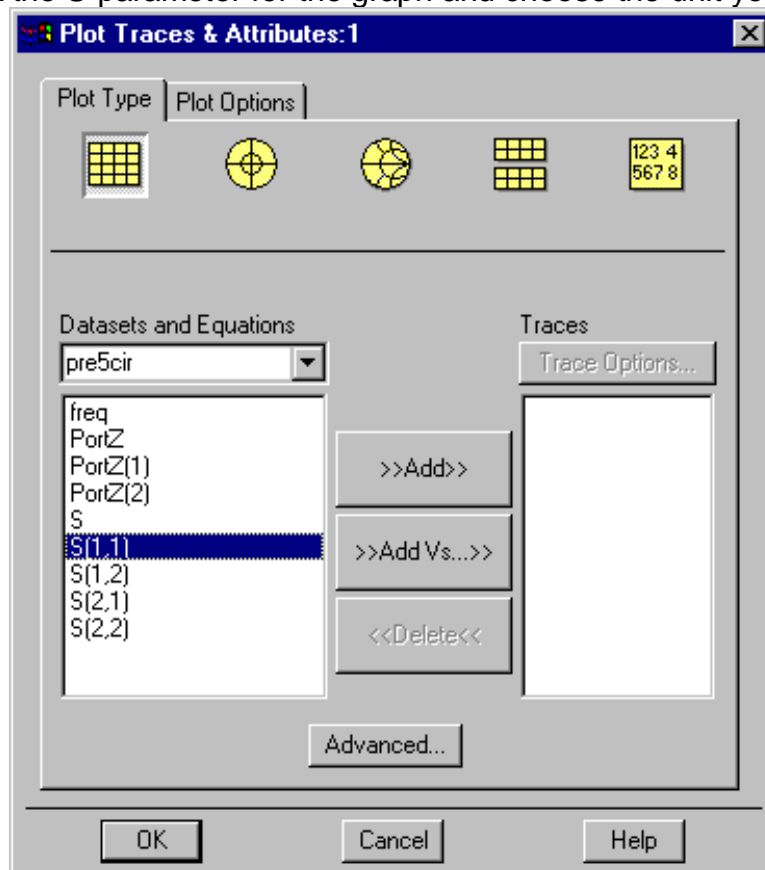

5. The graph is plotted and the Marker function is provided in the Marker menu bar.

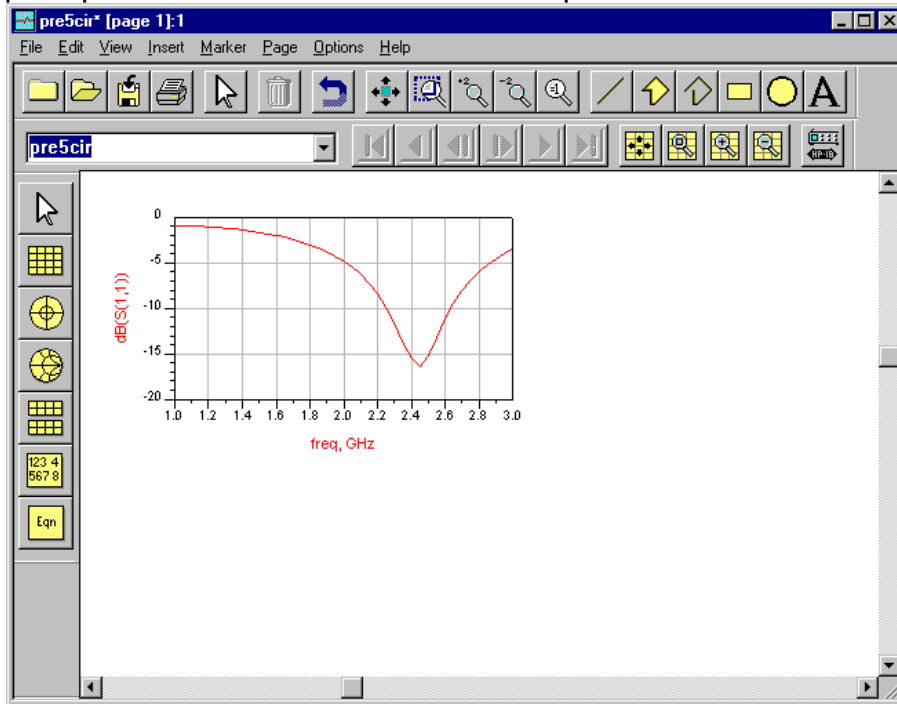

After finding the s-parameter of the circuit. The next step is to simulate the dc analysis. In the Simulation\_DC, we can get the DC.I\_Probe can be found in the proble\_components. We can start to get the DC basis simulation with the following schematic.

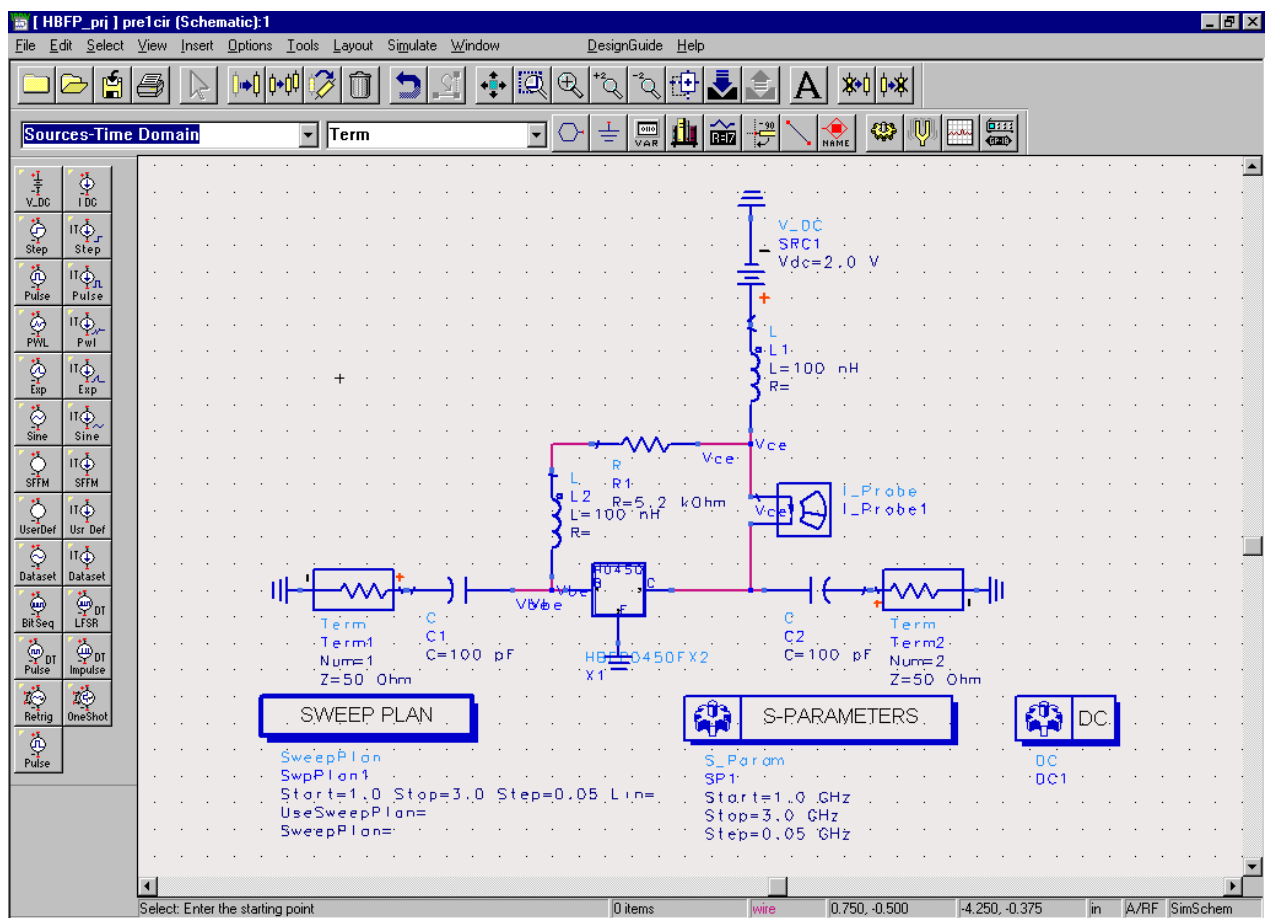



It is same as before. We use Simulate->Simulate to simulate the circuit. But we use "list" instead of rectangular plot for the graph. Double click the I-Probe.i to get the current value as following.

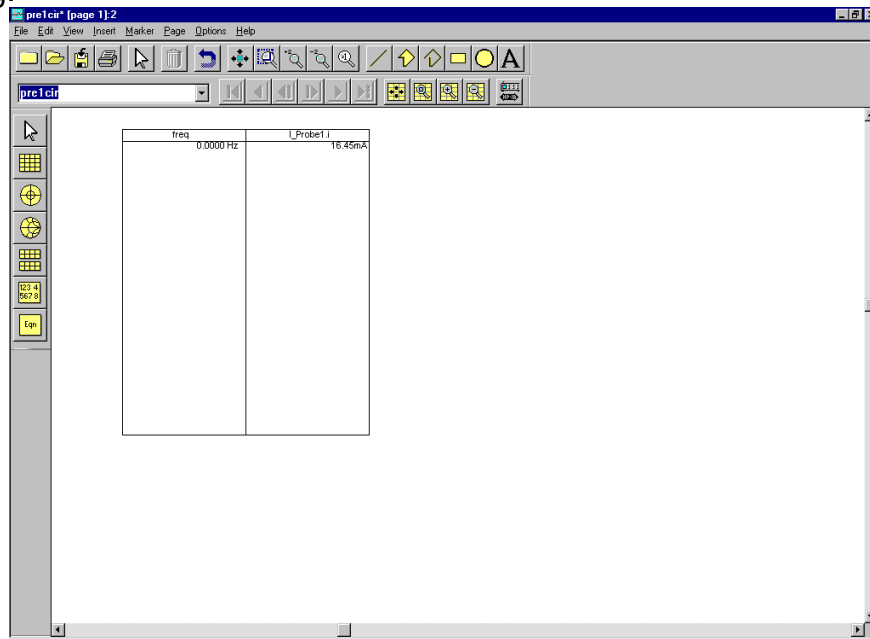

To get more accuracy, we can insert the transmission line into the circuit. The transmission line and short circuit stub can be found in the Tlines\_Microstrip category. And the micro-strip data is insert in MSUB icon.

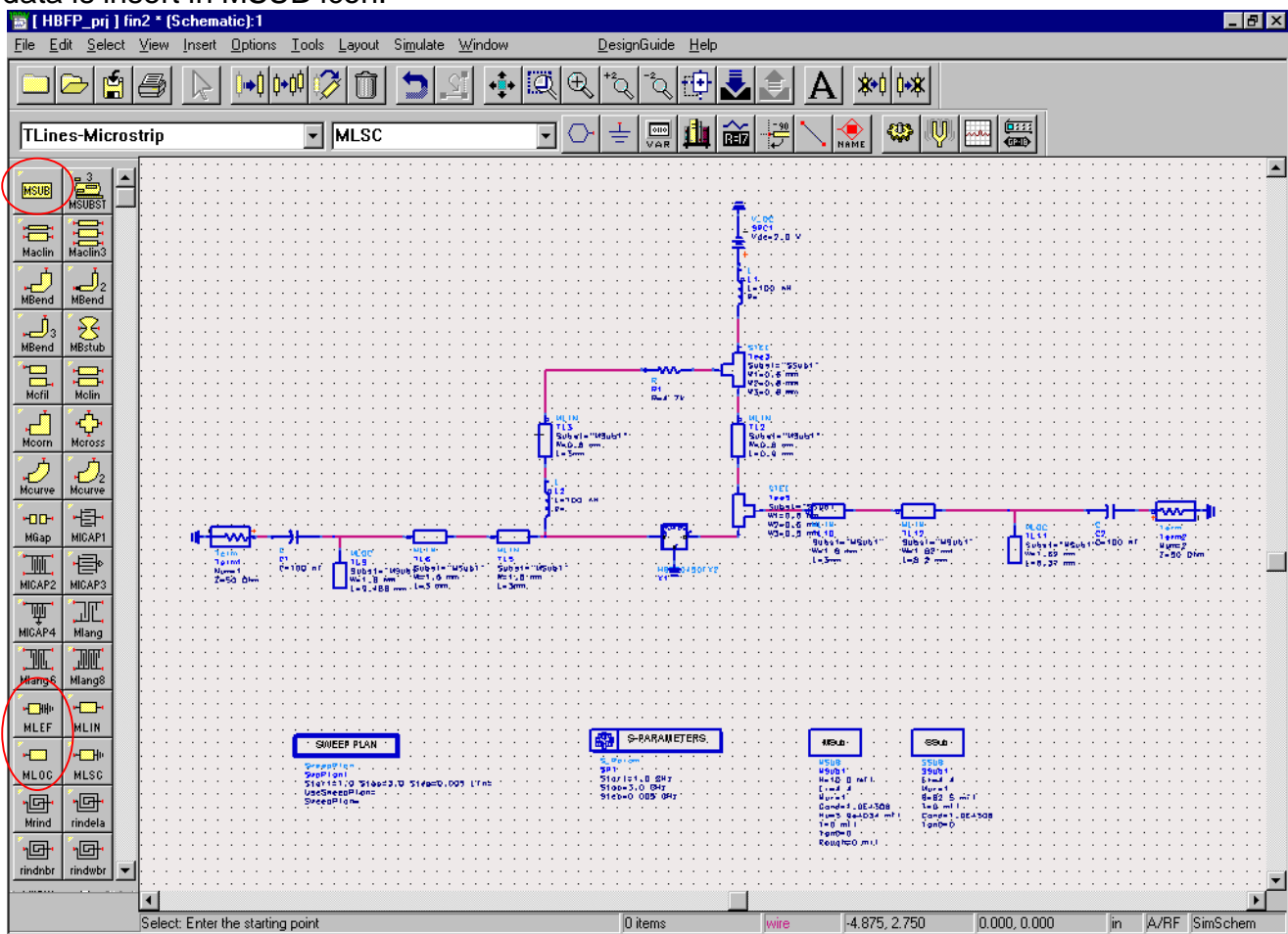

the tee connection can be found in the TLINE-Stripline for the three way connection.

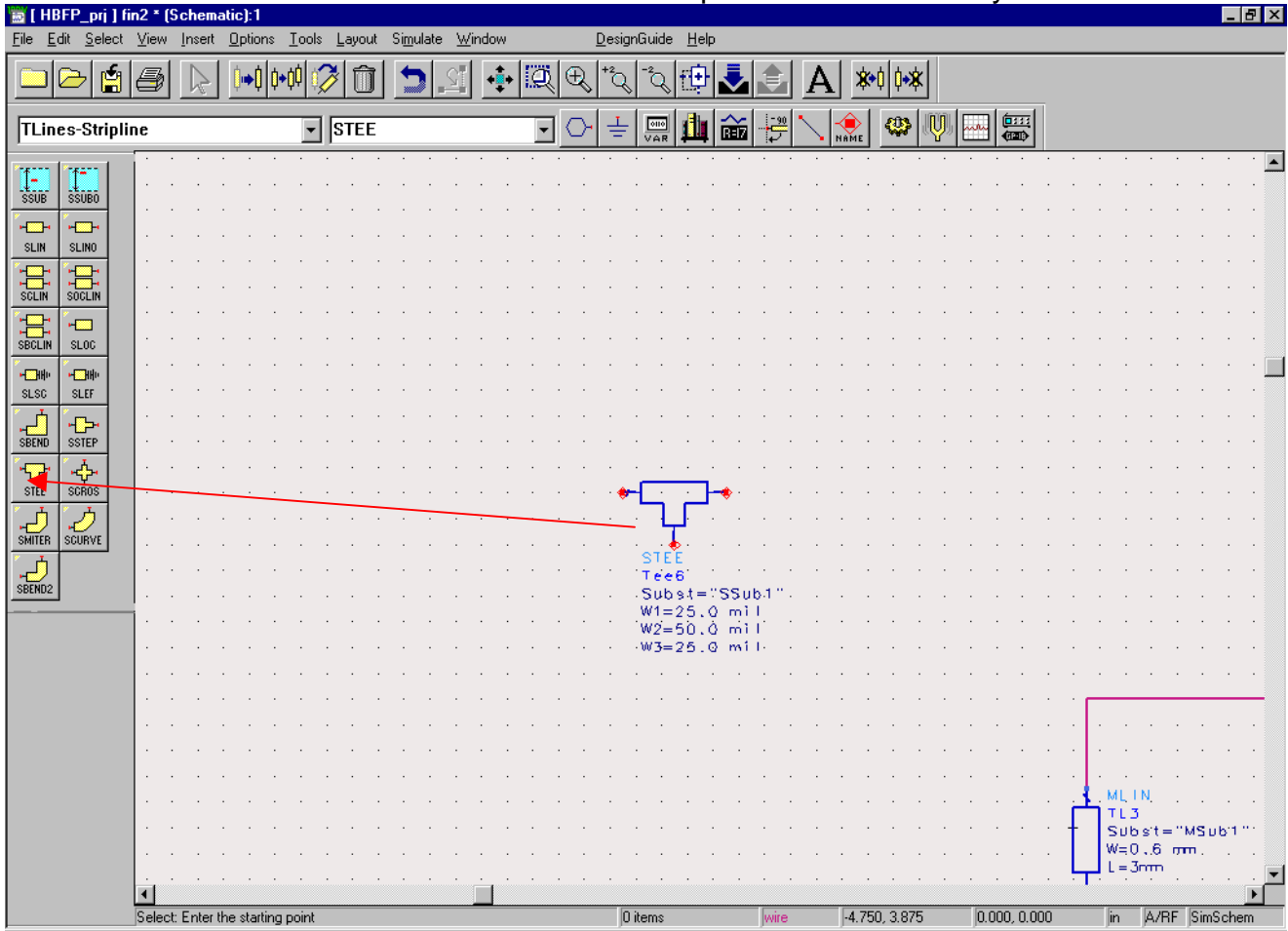

There is enough knowledge for the basic transmission line connection. For further information, it can be found in the menu of ADS in the project lab.